

# Collaboration Pods



# Collaboration Eco Pods

The Collaboration Pods provide the ideal environment for meetings in optimal conditions. They feature integrated comfortable benches, individual stools, or swivel chairs.

A screen panel can be mounted on the back or side wall to share digital content or facilitate video calls with multiple participants. The tapered table tops are designed to provide an unobstructed view of the screen.

- Built-in meeting tables are available in a variety of sizes at either 75 cm or 105 cm from the floor.

- Integrated meeting tables available in heights of 75 cm or 105 cm from the floor, in various sizes.

- Optional adjustable lighting and ventilation to optimize the meeting environment.

- The door hinge can be repositioned to the opposite side. An additional rear door is available.



# Eco Meet S

Collaboration Pods collection



Glass backside



Backpanel



Closed backside

**CAPACITY**

2 persons

**WEIGHT**

Pod 554 kg  
Crate 92 kg

**ACOUSTICS**

30,2 dB Cat A  
ISO 23351-1

**AIRFLOW**

141.6 cfm  
240 m<sup>3</sup>/h

**SUSTAINABLE**

64,9% recycled  
99,2% recyclability

**OPTIONAL**

- power sockets see pag 12
  - interior - exterior options see pag 13
  - adaptable ventilation & light see pag 14
- Water sprinkler intergrated on request

**INCLUDED**

- 2x led-lights 5W with sensor
- air ventilation
- door with magnetic closure

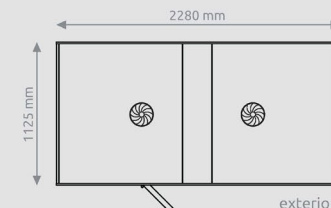
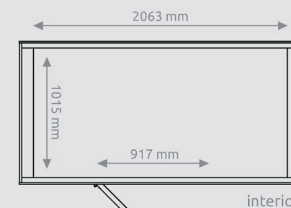
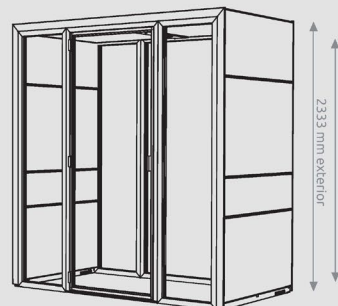

# Eco Meet M

Collaboration Pods collection



**Glass backside**



**Backpanel**



**Closed backside**

## CAPACITY

4 persons

## WEIGHT

Pod 607 kg  
Crate 92 kg

## ACOUSTICS

30,2 dB Cat A  
ISO 23351-1

## AIRFLOW

283.2 cfm  
480 m<sup>3</sup>/h

## SUSTAINABLE

68% recycled  
99,1% recyclability

## OPTIONAL

- power sockets see pag 12
  - interior - exterior options see pag 13
  - adaptable ventilation & light see pag 14
- Water sprinkler intergrated on request

## INCLUDED

- 2x led-lights 5W with sensor
- air ventilation
- door with magnetic closure

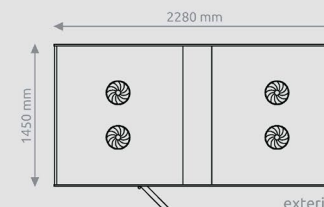
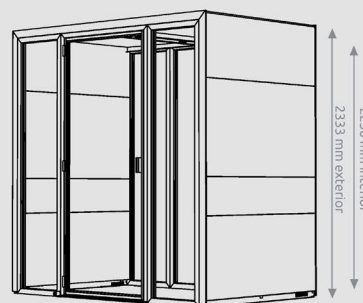

# Eco Meet L

Collaboration Pods collection



**Glass backside**



**Backpanel**



**Closed backside**

**CAPACITY**

4 to 6 persons

**WEIGHT**

Pod 694 kg  
Crate 92 kg

**ACOUSTICS**

30,2 dB Cat A  
ISO 23351-1

**AIRFLOW**

283.2 cfm  
480 m<sup>3</sup>/h

**SUSTAINABLE**

69,6% recycled  
99% recyclability

**OPTIONAL**

- power sockets see pag 12
  - interior - exterior options see pag 13
  - adaptable ventilation & light see pag 14
- Water sprinkler intergrated on request

**INCLUDED**

- 2x led-lights 5W with sensor
- air ventilation
- door with magnetic closure

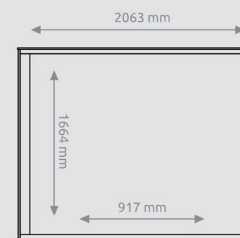
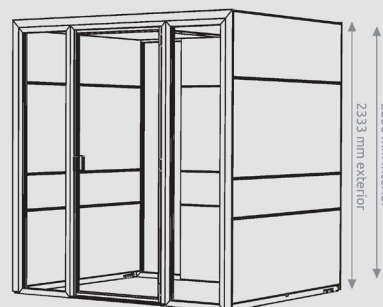

interior

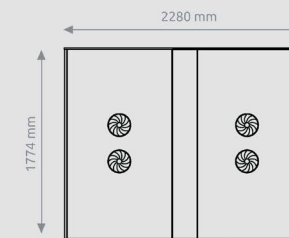

exterior

# Eco Meet XL

Collaboration Pods collection



**Glass backside**



**Backpanel**



**Closed backside**

## CAPACITY

6 to 8 persons

## WEIGHT

Pod 776 kg  
Crate 184 kg

## ACOUSTICS

30,2 dB Cat A  
ISO 23351-1

## AIRFLOW

283.2 cfm  
480 m<sup>3</sup>/h

## SUSTAINABLE

66,1% recycled  
99,1% recyclability

## OPTIONAL

- power sockets see pag 12
  - interior - exterior options see pag 13
  - adaptable ventilation & light see pag 14
- Water sprinkler intergrated on request

## INCLUDED

- 2x led-lights 5W with sensor
- air ventilation
- door with magnetic closure

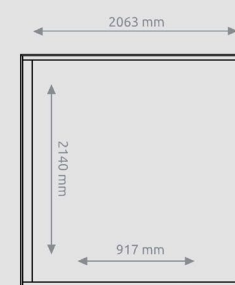
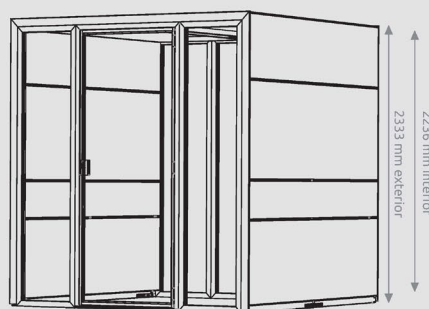

interior

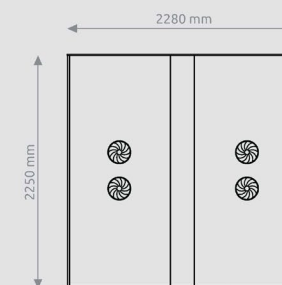

exterior

# Eco Meet M+

Collaboration Pods collection



**Glass backside**



**Backpanel**



**Closed backside**

**CAPACITY**

4 persons

**WEIGHT**

Pod 692 kg  
Crate 92 kg

**ACOUSTICS**

30,2 dB Cat A  
ISO 23351-1

**AIRFLOW**

283.2 cfm  
480 m<sup>3</sup>/h

**SUSTAINABLE**

66,1% recycled  
99,1% recyclability

**OPTIONAL**

- power sockets see pag 12
  - interior - exterior options see pag 13
  - adaptable ventilation & light see pag 14
- Water sprinkler intergrated on request

**INCLUDED**

- 2x led-lights 5W with sensor
- air ventilation
- door with magnetic closure

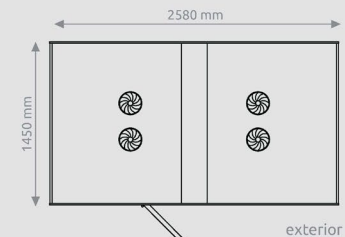
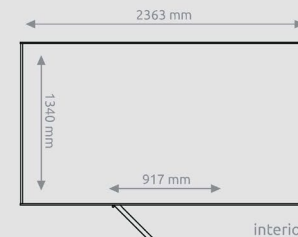
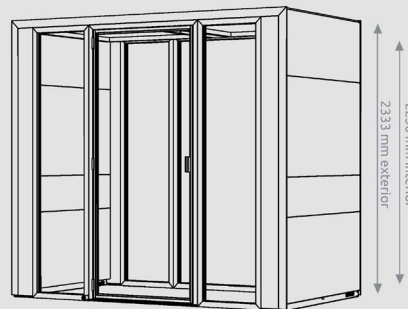

# Eco Meet L+

Collaboration Pods collection



Glass backside



Backpanel



Closed backside

**CAPACITY**

4 to 6 persons

**WEIGHT**

Pod 767 kg  
Crate 92 kg

**ACOUSTICS**

30,2 dB Cat A  
ISO 23351-1

**AIRFLOW**

283.2 cfm  
480 m<sup>3</sup>/h

**SUSTAINABLE**

69% recycled  
99% recyclability

**OPTIONAL**

- power sockets see pag 12
  - interior - exterior options see pag 13
  - adaptable ventilation & light see pag 14
- Water sprinkler intergrated on request

**INCLUDED**

- 2x led-lights 5W with sensor
- air ventilation
- door with magnetic closure

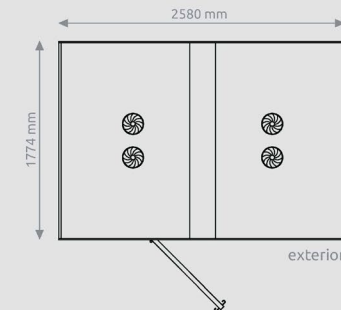
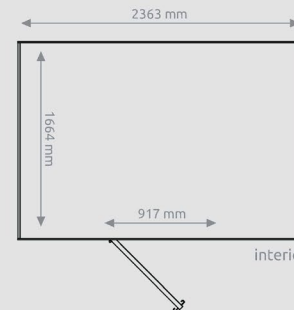
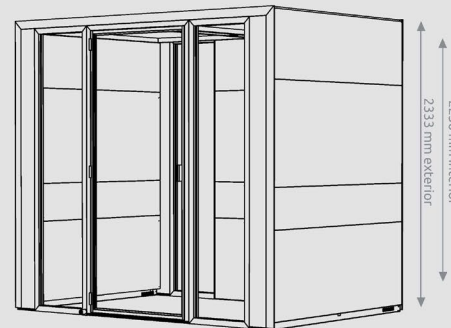

# Eco Meet XL+

Collaboration Pods collection



Glass backside



Backpanel



Closed backside

## CAPACITY

6 to 8 persons

## WEIGHT

Pod 868 kg  
Crate 184 kg

## ACOUSTICS

30,2 dB Cat A  
ISO 23351-1

## AIRFLOW

283.2 cfm  
480 m<sup>3</sup>/h

## SUSTAINABLE

72,2% recycled  
98,9% recyclability

## OPTIONAL

- power sockets see pag 12
  - interior - exterior options see pag 13
  - adaptable ventilation & light see pag 14
- Water sprinkler intergrated on request

## INCLUDED

- 2x led-lights 5W with sensor
- air ventilation
- door with magnetic closure

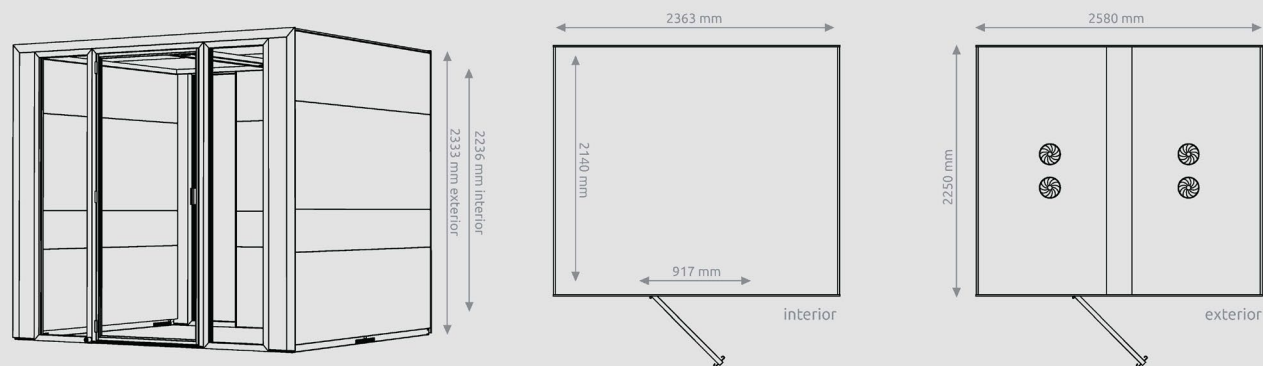

# Eco Team XL

Collaboration Pods collection



**Glass backside**



**Backpanel**



**Closed backside**

## CAPACITY

6 to 8 persons

## WEIGHT

Pod 960 kg  
Crate 184 kg

## ACOUSTICS

30,2 dB Cat A  
ISO 23351-1

## AIRFLOW

424.8 cfm  
720 m<sup>3</sup>/h

## SUSTAINABLE

70% recycled  
99% recyclability

## OPTIONAL

- power sockets see pag 12
  - interior - exterior options see pag 13
  - adaptable ventilation & light see pag 14
- Water sprinkler intergrated on request

## INCLUDED

- 2x led-lights 5W with sensor
- air ventilation
- door with magnetic closure

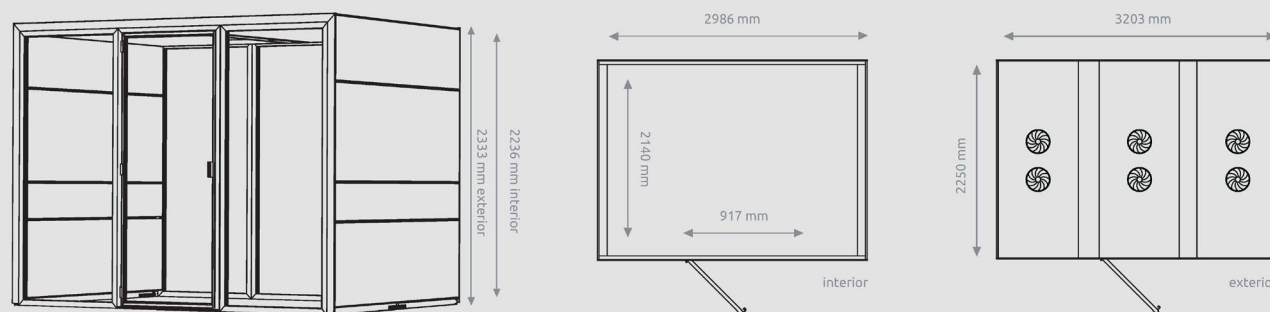

# Eco Max XL

Collaboration Pods collection



**Glass backside**



**Closed backside**

**CAPACITY**

8 to 10 persons

**WEIGHT**

Pod 1160 kg  
Crate 184 kg

**ACOUSTICS**

30,2 dB Cat A  
ISO 23351-1

**AIRFLOW**

424.8 cfm  
720 m<sup>3</sup>/h

**SUSTAINABLE**

67,7% recycled  
99% recyclability

**OPTIONAL**

- power sockets see pag 12
  - interior - exterior options see pag 13
  - adaptable ventilation & light see pag 14
- Water sprinkler intergrated on request

**INCLUDED**

- 2x led-lights 5W with sensor
- air ventilation
- door with magnetic closure

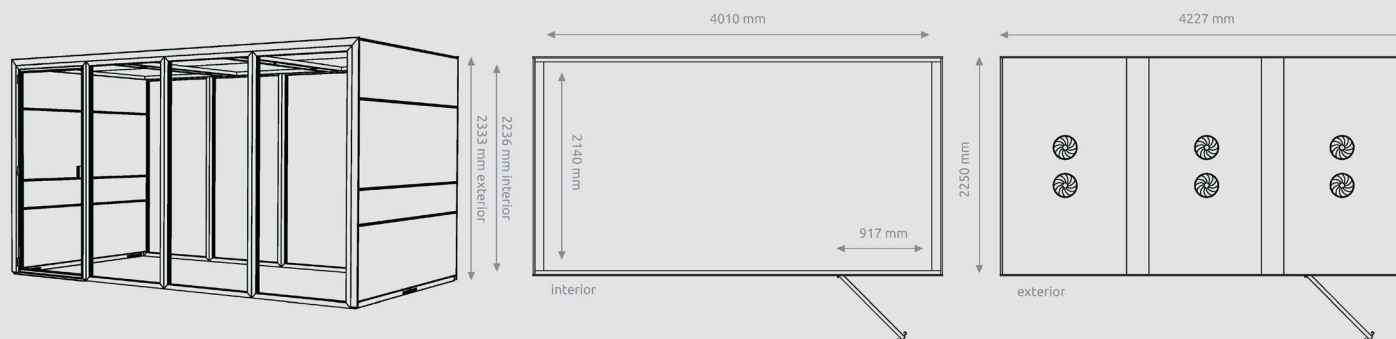

# INTEGRATED POWER SOCKET OPTIONS



## POWER SOCKET STANDARD

- 230 volt RA including 20cm cable GST18
- 68mm diameter
- 56mm installation depth
- sockets for foreign countries, available on request.



## UTP Cat6 2x

- Two UTP ports included.
- 68mm diameter
- 56mm installation depth
- No cables included for ports at the backside



## USB SPEED CHARGING

- 2x USB port include including 200mm cable GST18
- 68mm diameter
- 56mm installation depth
- For fast charging your phone, laptop or other devices.



## Cat6 UTP + 1x HDMI

- 1x UTP Cat6 port included
- 1x HDMI included
- 68mm diameter
- 56mm installation depth
- No cables included for ports at the backside.



## POWER SOCKET XL

- 230 volt, USB A and USB -C included.
- Diameter 84mm
- 73mm installation depth
- Including 200mm cable GST-18.
- Sockets for foreign countries available on request.



# INTEGRATED INTERIOR OPTIONS

The generic components of each Pod are interchangeable. This allows for flexible configurations, such as replacing an upholstered panel with an integrated whiteboard or a laminated panel with a built-in tabletop. As a result, the Pod's functionality can be easily adapted at any later stage. Even a Meeting Pod for multiple users can be transformed into a Focus Pod for individual use.



Meeting table low



Meeting table high  
Screenpanel



Bridge table low



Desk



Bridge table high



Screenpanel  
Shelf and Sofa



Backside table



Lounge furniture

## INTEGRATED LIGHTING & VENTILATION

A small motion detection sensor integrated in the ceiling activates the ventilators in the roof and the integrated LED lights in the ceiling when someone enters the Pod.  
The silent ventilators suck out the hot air, creating an airflow from bottom to top. Cold air is coming in through small holes in the floor plinths, refreshing the air inside the pod in 2 minutes.  
The temperature inside the Pods remains consistent with the surrounding environment, even when occupied by multiple people.

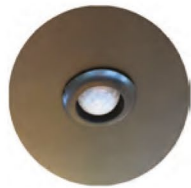

230 volt RA



ventilation slots



ventilators



7-watt led spots



## ELECTRIFICATION & CABLE MANAGEMENT

The Pods can be connected to the network of building from each side at the floor or from the ceiling if preferred. Pods with a Mid-panel integrated in the back have an extra option using a 60mm diameter grommet placed 3cm above the floor in the middle.

Because the panels on the outside and inside of the Pod can be removed, a cable channel inside the wall is accessible and cables can be guided in any direction. All Pods are supplied with a four-gang GST18 power block and two five-meter GST18 cables to connect the Pod with power sockets to the building.

different  
power modulespower cables  
with GST18 plugcable splitter  
for connectingGST18 power block  
integrated in ceiling tray